



## Research Paper

**CONTROL OF CO<sub>2</sub> LASER POWER BY ACOUSTIC FIELDS**

A.S. Abrahamyan\*, R.Yu. Chilingaryan

Institute of Applied Problems of Physics,  
Hrachya Nersissian Str. 25, Yerevan, 0014, Republic of Armenia**Abstract**

The present study investigates the optimization of the operation of the CO<sub>2</sub> laser in the acoustoplasma mode (i.e., dependence of the laser radiation power on the composition of the working mixture, pressure, value of the direct component of the discharge current, frequency, and modulation depth).

A three-dimensional dependence on the frequency and modulation depth of the discharge current is experimentally obtained for the normalized efficiency of the conversion of the electric power supplied to the discharge tube into laser power.

The maximum gain when transition to the acoustoplasma mode exceeds 2.5 times. The optimum depth of the discharge current modulation is 0.5–0.7.

The laser radiation power modulation caused by the discharge current modulation is measured. Laser power is not modulated at modulation frequencies of current >1 kHz. Meanwhile, at current modulation frequencies <0.5 kHz, the modulation depth of the laser radiation power nonlinearly depends on the modulation depth of the discharge current and has a threshold character.

The modulation depth of the laser radiation power is associated with the creation of an acoustoplasma and not simply with the discharge current modulation.

*Key words:* acoustoplasma, CO<sub>2</sub> laser, laser power, laser mixture

**1. Introduction**

The first observation of the laser generation on CO<sub>2</sub> molecules was reported by Patel [1].

The population of the upper laser level in the absence of generation is [2]

$$N_{001} = \langle jE \rangle \eta \frac{\tau_{\text{CO}_2}}{\varepsilon_{001}}, \quad (1)$$

where  $\langle jE \rangle$  is the average power density released in the positive column of the discharge;  $j$  is the cur-

rent density;  $E$  is the field strength; and  $\varepsilon_{001}$  is the energy of the upper-level 001.

In the presence of nitrogen in the mixture, the relaxation time of the energy stored by the upper-level  $\tau_E$  increases and becomes equal to

$$\tau_E = \tau_{\text{CO}_2} \frac{P_{\text{CO}_2} + P_{\text{N}_2}}{P_{\text{CO}_2}} > \tau_{\text{CO}_2}, \quad (2)$$

where  $P_{\text{CO}_2}$  and  $P_{\text{N}_2}$  are the partial pressures of CO<sub>2</sub> and N<sub>2</sub>, respectively. I.e., with an increase of the partial nitrogen pressure, the relaxation time of the upper level of the CO<sub>2</sub> molecule increases.

The optimization of the CO<sub>2</sub> laser mixture should be performed for each individual situation in the discharge, including when the plasma interacts with an acoustic field.

\* Corresponding authors: Institute of Applied Problems of Physics, Hrachya Nersissian Str. 25, Yerevan, 0014, Republic of Armenia E-mail: [arbel11@mail.ru](mailto:arbel11@mail.ru)

The discharge modes can be conditionally divided into three types: stationary (including DC discharge), dynamic (pulse-periodic or at a higher frequency), and quasi-stationary (at a relatively low frequency). In a stationary discharge, all discharge parameters have time to take their new stationary values when the current changes. In a dynamic discharge with a rapid change of current, most of the discharge parameters do not have time to take stationary values. In a quasi-stationary discharge, some parameters do not have time to take stationary values. In the case of a dynamic and quasi-stationary discharge, the characteristics of the plasma can be controlled by changing the parameters of the discharge current modulation.

Let us consider in detail the quasi-dynamic mode. When fed with a modulated discharge current containing a constant and variable component, that creates acoustic oscillations in the discharge, for which the discharge tube is an acoustic resonator. The results of experimental studies on sound generation and amplification in the discharge of some pure gases with a narrow range of measured values are given in reviews [3–9]. An acoustic instability caused by the interaction of acoustic waves with low-temperature plasma results in a new plasma state, called acoustoplasma. The acoustoplasma state differs in its parameters from plasma without acoustic perturbation [10, 11].

The ultimate goal of the whole cycle of work is the creation of a new CO<sub>2</sub> laser with improved characteristics, in particular, increased efficiency and power of radiation.

The present study investigates the effect of the acoustoplasma mode on the CO<sub>2</sub> laser parameters.

## 2. Experimental setup

According to its functional purpose, the experimental setup consisted of vacuum equipment, dis-

charge tubes, a high-voltage power supply, and a measuring complex.

The vacuum equipment had a conventional design. The difference was that the discharge tube was connected to the ballast volume of the vacuum equipment through a thin capillary with an inner diameter <1 mm. In this case, the pressure in the discharge tube remained constant, regardless of the discharge current. However, acoustic oscillations remained in the discharge tube and did not penetrate into the ballast volume.

The vacuum equipment allowed to pump out the discharge tube to pressures below 1 Pa (<0.01 torr) and fill the tube with a working mixture in the pressure range of 1–30.000 Pa (~0.01–300 torr).

For convenience, we used only *torr* for the extra-system unit of pressure.

Pressures above 50 torr and below 2 torr were not considered herein.

The vacuum equipment allowed filling a special container with a gas mixture or clean gases at a pressure close to the atmospheric one and, if necessary, filled the discharge tube from this container. This excluded the difference in the gas mixture during the experiment and overfilling of the discharge tube.

The discharge tubes had different designs. A discharge tube GL-502 of a commercial LG-23 CO<sub>2</sub> laser [12] and specially manufactured discharge tubes were used. The GL-502 tube was used to avoid the question of the effect of the tube design on the results obtained in optimizing the parameters when the acoustoplasma mode and the DC power mode (standard mode) were compared. The GL-502 tube was soldered with a glass fitting such that it could be filled with different gases at different pressures.

Figure 1 shows the GL-502 tube design. The discharge gap length was 500 mm. The discharge channel diameter was 12 mm. The LG-23 laser had a radiation power of several *watts* in a continuous single-mode regime. The radiation wavelength was 10.6 μm.

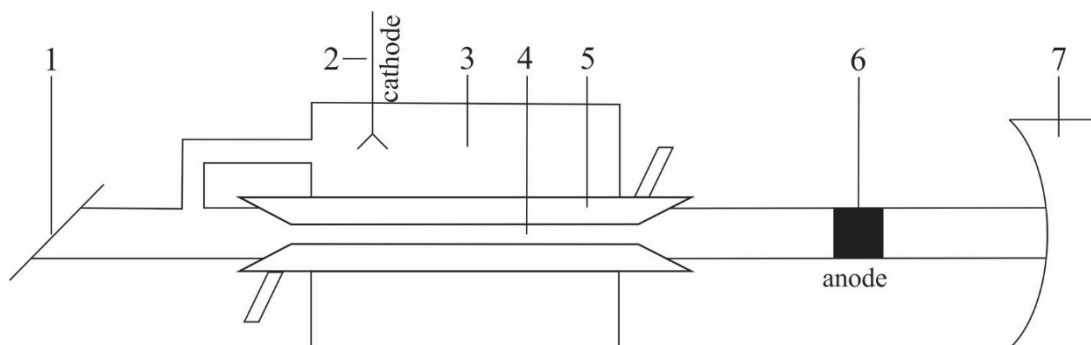

**Fig. 1.** Design of the GL-502 discharge tube of the LG-23 laser. 1 – GaAs Brewster window; 2 – cathode; 3 – ballast volume; 4 – discharge channel; 5 – water jacket; 6 – anode; and 7 – blind mirror of the resonator

Figure 1 shows the tube consisting of several coupled acoustic resonators.

In the range of 0.01–1 kHz, the tube had 11 resonant frequencies [13]. The acoustic modes were strongly attenuated with the increasing frequency because of the Brewster window. The Q-factor of the acoustic resonator had a small value at low resonance frequencies  $>1$  kHz.

For the discharge tube made in the laboratory, the internal diameter of the discharge channel was 5 mm.

The discharge parameters and the produced discharge tubes were chosen in such a manner that the similarity relations [14] with the GL-502 discharge tube were satisfied.

The power source made it possible for one to change the constant discharge current (1–50 mA) and voltage (0–25 kV), modulation frequency (0–20 kHz), and modulation depth (0–1). We used a current generator circuit to supply the discharge [15].

The average power of the laser radiation was measured with the IMO-2N power meter. The variable power component of the laser radiation was measured with a BKM-5 bolometer. Considering the fact that the time constant of the BKM-5 bolometer was of the order of 1 ms, the measurement of the variable component of the laser radiation power was performed at a 30–200 Hz modulation frequency of the discharge current.

The standard working mixture of the CO<sub>2</sub> laser CO<sub>2</sub>:N<sub>2</sub>:He = 1:1:8 was chosen as the main working mixture, at which all the results could be evaluated. The laser mixtures of the other compositions were also studied.

### 3. Results and discussion

The dependence of the laser radiation power in the infrared (IR) range (10.6  $\mu\text{m}$ ) on the modulation frequency of the discharge current was investigated. Figure 2 shows the dependence of the laser radiation power on the pressure of the working mixture in a discharge tube for different CO<sub>2</sub>:N<sub>2</sub>:He mixtures when working at a constant current  $I_0 = 5$  mA.

Note that mixtures not shown in Fig. 2 had a very low laser radiation power both when the discharge was powered by a direct current and in the acousto-plasma mode; therefore, they are not given in this work.

The horizontal axis represents the pressure of the working mixture in *torr*, and the vertical axis indicates the laser radiation power in *watts*.

Figure 2 shows that when working at a direct current (at low current values), the most optimal working mixtures were CO<sub>2</sub>:N<sub>2</sub>:He = 3:1:8 and CO<sub>2</sub>:N<sub>2</sub>:He = 2:2:8, which made it possible to obtain the greatest efficiency of laser generation. The working mixture of CO<sub>2</sub>:N<sub>2</sub>:He = 1:1:8 was inferior to those mixtures at the maximum generation power; however, the laser power of the CO<sub>2</sub>:N<sub>2</sub>:He = 1:1:8 working mixture was almost independent of the pressure, and the remaining mixtures had characteristic maximums depending on the pressure.

Figure 2 shows that when the DC power is supplied to different mixtures, the dependence of the laser radiation power on the value of the direct current is given. The pressure of the working mixture always remained equal to 10 torr.

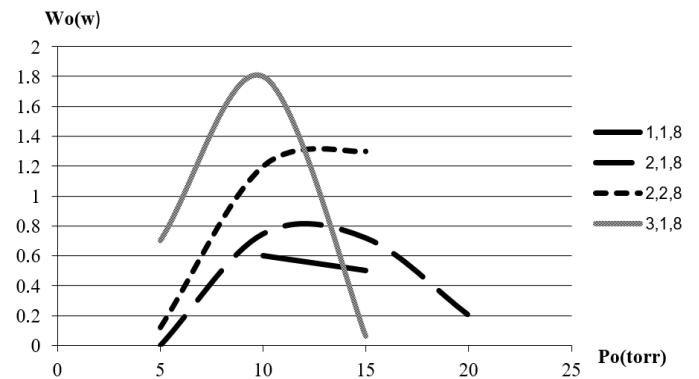

**Fig. 2.** Dependence of the laser radiation power on the gas pressure for different working mixtures when working at a constant current  $I_0 = 5$  mA

Figure 3 depicts that the laser radiation power for the working mixture of CO<sub>2</sub>:N<sub>2</sub>:He = 1:1:8 depended little on the value of the direct current. For the other working mixtures, the power of the laser radiation sharply decreased with the increasing current. The mixture of CO<sub>2</sub>:N<sub>2</sub>:He = 3:1:8 had a particularly narrow discharge current peak.

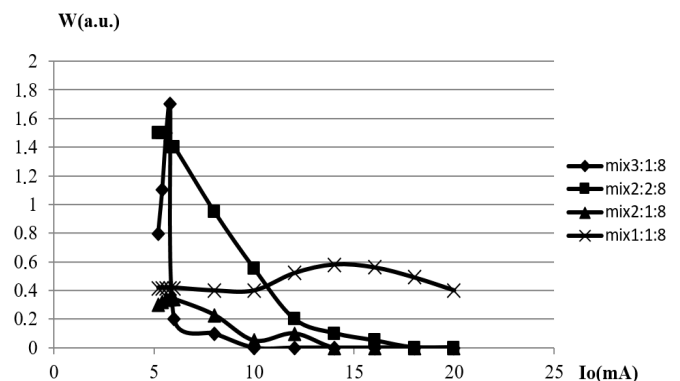

**Fig. 3.** Optimization of the constant component of the discharge current for different working mixtures

In the acoustoplasma mode, the discharge current varied around its mean value during the modulation period. If the maximum power modulation is required, the working mixture of  $\text{CO}_2:\text{N}_2:\text{He} = 3:1:8$  should be chosen. If the radiation power needs to be stabilized, the working mixture of  $\text{CO}_2:\text{N}_2:\text{He} = 1:1:8$  must be chosen because it depends less on the discharge current and, therefore, will most clearly show dependence on the acoustoplasma phenomenon.

Figure 3 implies that for the  $\text{CO}_2:\text{N}_2:\text{He} = 1:1:8$  laser mixture, the optimum value of the discharge current constant component was 10–15 mA.

Figure 4 shows the dependence of the normalized power of the laser radiation in the acoustoplasma mode on the depth and frequency of the discharge current modulation.

The horizontal axis represents the modulation depth of the discharge current  $M = I(\sim)/I_0$ , where  $I(\sim)$  is the amplitude of the variable component of the discharge current, and  $I_0$  is the magnitude of the constant component of the discharge current. The vertical axis represents the normalized power of the laser radiation in the acoustoplasma mode  $W(f)/W(0)$ , where  $W(f)$  is the average power of the

laser radiation in the acoustoplasma mode when the discharge current is modulated with frequency  $f$ , and  $W(0)$  is the laser radiation power when the discharge is powered by a direct current. For both cases, the constant component of the discharge current was the same at  $I_0 = 10$  mA. The solid lines correspond to the average values. The fine dotted and dashed lines correspond to the maximum and minimum values obtained in the experimental series, respectively. The root mean square deviations are typically much smaller and very often of the order of the thickness of the solid line. The increase in the deviations of the minimum and maximum values from the mean at a large depth of modulation were caused by the acoustoplasma mode becoming unstable and the phase transitions that can occur between different acoustoplasma states and between an acoustoplasma state and the plasma state without acoustic perturbation [16, 17].

The maximum modulation depth in the experiments was  $M = 1.2$ ; however, after  $M = 1$ , the discharge current became not sinusoidal, and it was impossible to speak of a pulsed current about the sinusoidal modulation of the discharge.

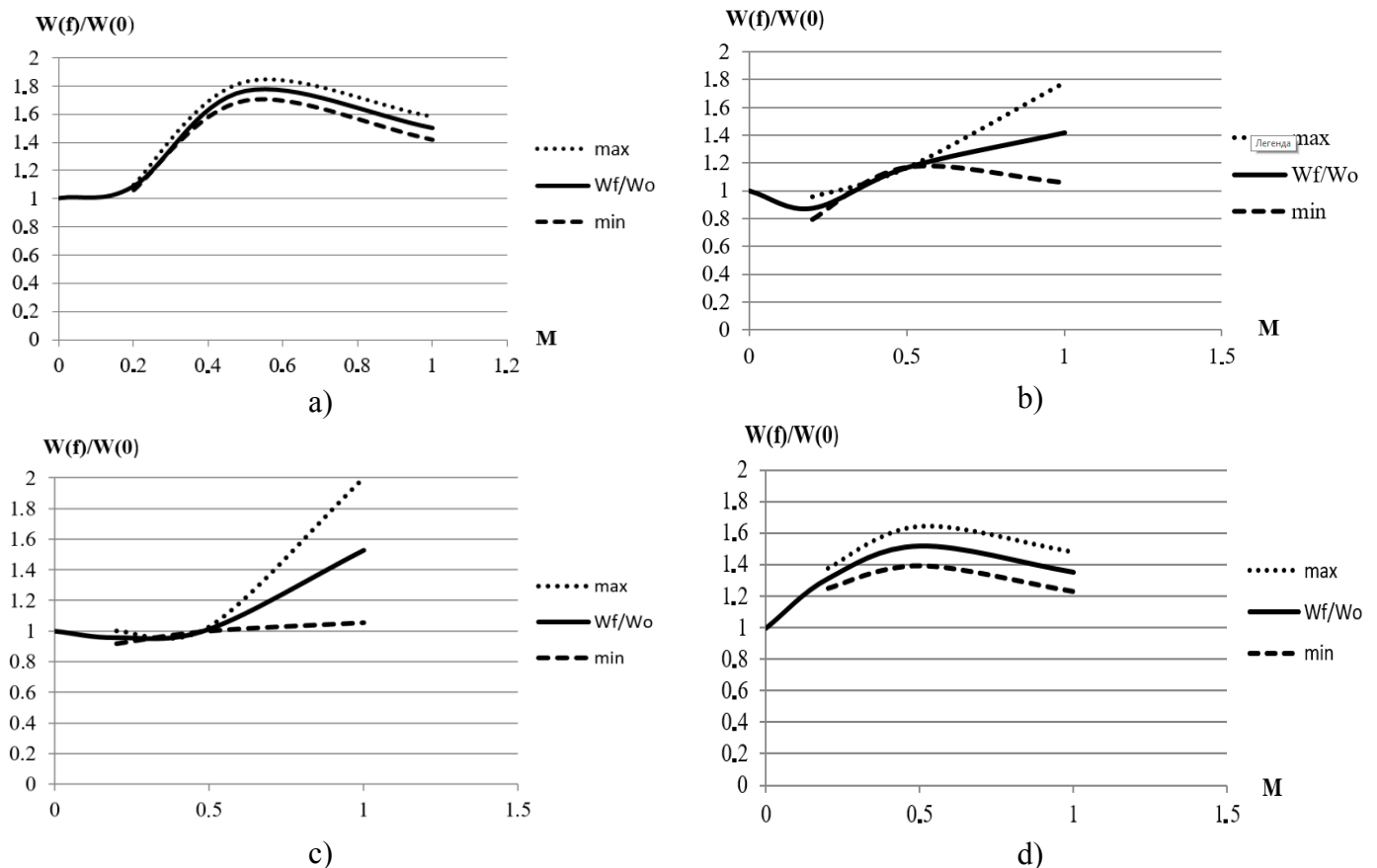

**Fig. 4.** Dependence of the normalized power of the laser radiation in the acoustoplasma mode on the modulation depth of the discharge current  $M$  for different modulation frequencies, the working mixture of  $\text{CO}_2:\text{N}_2:\text{He} = 1:1:8$ , the working mixture pressure of  $P_0 = 10$  torr, and  $I_0 = 10$  mA. a)  $f = 0.1$  kHz; b)  $f = 0.5$  kHz; c)  $f = 1$  kHz; and d)  $f = 4$  kHz

Figure 4 shows that for all the modulation frequencies, the modulation depth  $M \approx 0.5$  was the most optimal.

For the modulation frequency of 0.1 kHz at the modulation depth of 0.2, the normalized power was 1 (i.e., the advantages of the acoustoplasma mode were not present). With an increase in the modulation depth from 0.2 to 0.5, the average power of laser radiation in the acoustoplasma mode increased 1.7 times in comparison with the laser radiation power when the discharge was powered by a direct current. In the region of modulation depths of 0.5–0.6, an increase of order 1.8 (Fig. 4a) of saturation was observed; then, with an increase in the modulation depth from 0.6 to 1 this increase was reduced of order 1.5 (Fig. 4a).

For the modulation frequency of 0.5 kHz (Fig. 4b) at a modulation depth of 0.2, the average power of the laser radiation in the acoustoplasma mode decreased by 1.1 times in comparison to the DC operation. With a further increase in the modulation depth from 0.2 to 1, the power in the acoustoplasma mode increased to 1.5 times in comparison with the DC power.

For the modulation frequency of 1 kHz (Fig. 4c) to a modulation depth of 0.5, no advantages to the acoustoplasma mode were found. With an increase in the modulation depth from 0.5 to 1, the average power of the laser radiation in the acoustoplasma mode linearly increased by a factor of 1.5 compared to the DC power.

For the modulation frequency of 4 kHz (Fig. 4d), the normalized power of the laser radiation increased for 1.5 times as the modulation depth increased from 0 to 0.5. The normalized power became 1.4 with a further increase in the modulation depth.

Thus, at a modulation depth of  $M = 1$ , the average power of the laser radiation in the acoustoplasma mode was 1.5 times greater than when fed by a direct current. With a modulation depth from 0 to 0.5, the normalized power behavior depended on the frequency.

Figure 5 shows a three-dimensional graph with the normalized power surface depending on the modulation frequency and the direct component of the discharge current for the modulation depth  $M = 0.5$ . For the working mixture of  $\text{CO}_2:\text{N}_2:\text{He} = 1:1:8$ .

Figure 5 depicts that with the modulation depth of  $M = 0.5$ , the optimal modes of the operation providing the greatest gain in the acoustoplasma mode

were the low modulation frequency  $f = 100$  Hz and the discharge direct current component  $I_0 = 10$  mA, with a gain of 1.7 times. For frequencies  $f = 1$  kHz and  $f = 4$  kHz, the optimum direct component of the discharge current was  $I_0 = 15$  mA. In this case, the gain was 1.4–1.5 times.

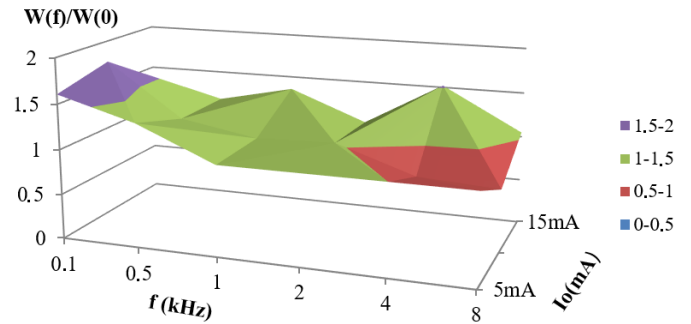
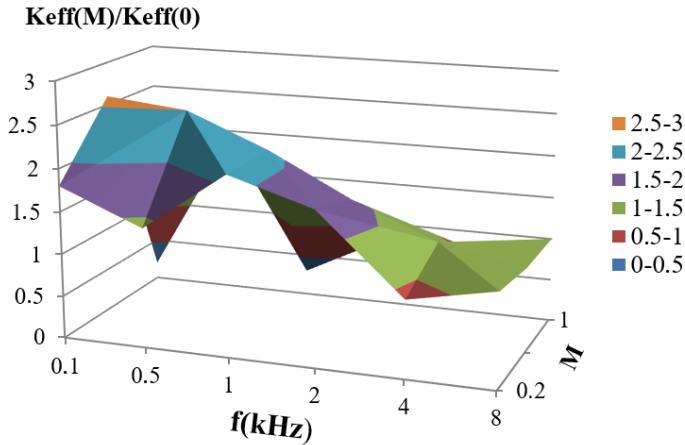

**Fig. 5.** 3D surface of the normalized power depending on the modulation frequency and the direct component of the discharge current for the modulation depth  $M = 0.5$

The peaks and dips of the normalized power at current  $I_0 = 15$  mA were clearly visible depending on the modulation frequency because of the acoustic resonance phenomena in the discharge tube, for which the frequency of the first longitudinal acoustic mode was  $f_1 \approx 0.5$  kHz. Two standing half-waves or one wave of the modulating frequency can fit at a frequency of  $f = 1$  kHz. The data for calculating the resonance frequencies were taken from [18].

Figure 6 shows that after the modulation frequency  $f = 0.5$  kHz, the normalized efficiency decreased, and no advantages of the acoustoplasma mode in comparison with the DC power supply were found for frequencies  $>4$  kHz. For the modulation frequencies in the 0.1–0.5 kHz region, the gain was 2.5 times.

The normalized efficiency is the ratio of the efficiency in the acoustoplasma operation mode ( $K_{\text{eff}}(M)$ ) to the efficiency at DC ( $K_{\text{eff}}(0)$ ) power supply.  $K_{\text{eff}}$  is the conversion factor of the electric power that is applied to the tube into the optical power of the laser radiation. If we consider that in the acoustoplasma mode, the intensity of the constant component of the electric field is less than when fed by a direct current [18] and when it is assumed that  $j$  and  $\tau_{\text{CO}_2}$  retain their significance, regardless of the acoustoplasma mode or DC power, then the inhibition of the upper laser level in the acoustoplasma mode should increase even more than the efficiency.

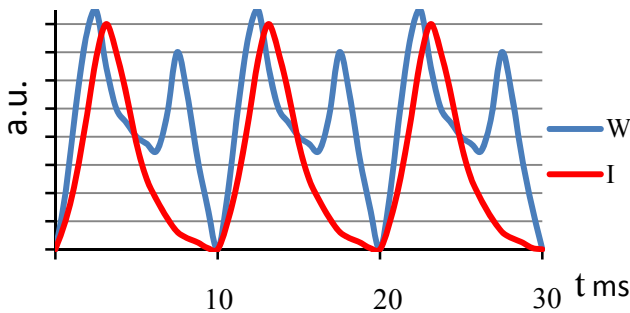

**Fig. 6.** 3D surface of the normalized efficiency of the conversion of electrical power to optical power from the frequency and modulation depth for the discharge current  $I_0 = 10$  mA and the pressure of the working mixture  $\text{CO}_2:\text{N}_2:\text{He} = 1:1:8$ ;  $P_0 = 10$  torr

Thus, the following parameters are optimal for the measurements in the acoustoplasma mode of the optical characteristics: working mixture –  $\text{CO}_2:\text{N}_2:\text{He} = 1:1:8$ , pressure in the discharge tube  $P_0 = 10$  torr, magnitude of the direct component of the discharge current  $I_0 = 10$  mA, modulation frequency  $f = 0.1\text{--}0.5$  kHz, and modulation depth  $M = 0.5\text{--}1$ .

We considered earlier the average power of laser radiation in the acoustoplasma mode. However, the instantaneous change in the laser radiation power in the acoustoplasma mode associated with the discharge current modulation (i.e., alternate component of the laser radiation power) also represents an interest.

In Fig. 7, the discharge current direct component  $I_0 = \langle I \rangle = 10.9$  mA;  $\langle I \rangle$  is the average current value for the modulation period. The modulation depth of the discharge current is  $M_I = 0.8$ . The average laser radiation power is  $\langle W \rangle = 0.86$  W. The modulation depth of the laser radiation is  $M_W = 0.6$ .



**Fig. 7.** Change in time over three periods of discharge current modulation, modulation frequency  $f = 100$  Hz, and modulation depth  $M_I = 0.8$ : the blue curve denotes the instantaneous value of the laser radiation power, and the red curve depicts the instantaneous value of the discharge current measured from the anode side (in a.u.)

Figure 8 illustrates that the modulation depth of the laser radiation power is maximal at a current modulation depth of the order of  $M_I \sim 0.7\text{--}0.9$ . The modulation depth of the laser radiation power is  $M_W = 0.11$  with the current modulation depth  $M_I = 1.2$  (the maximum attainable modulation depth is  $M_I = 1.3$  [19]). The modulation depth of the laser radiation power with a current modulation depth of 0.6 and below is also  $M_W < 0.1$ . The laser radiation modulation for the modulation frequency of the discharge current  $f = 1$  kHz and higher (at a modulation depth  $M_I < 0.6$ ) is practically unnoticeable.

The parabola approximation shows that the radiation power modulation should decrease to zero with the decrease of the current modulation depth to 0.5. In the experiments, the radiation power modulation became invisible at a current modulation depth of  $M_I < 0.3$ .

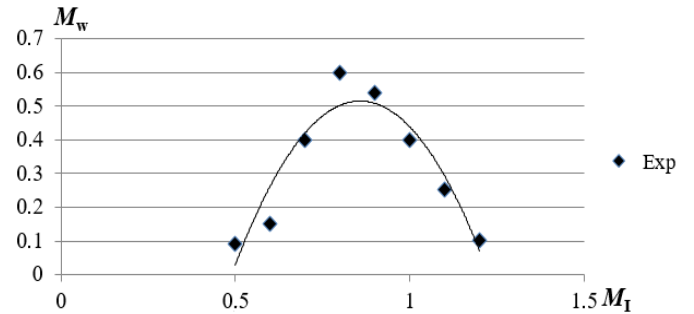
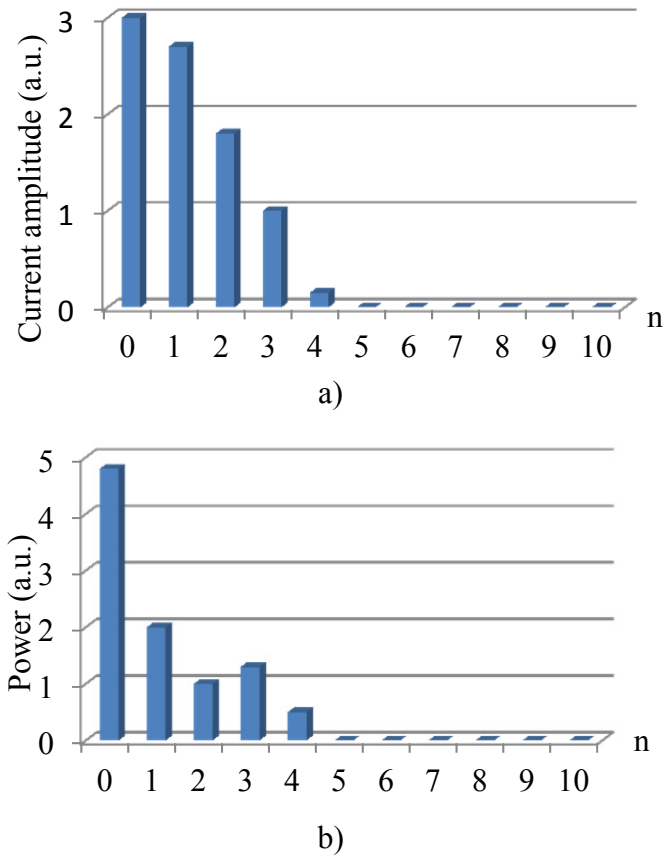

**Fig. 8.** Dependence of the modulation depth of the laser radiation power on the modulation depth of the discharge current. The points denote experimental data. The black curve is the parabola approximation  $M_W = -2.28 + 6.51 M_I - 3.79 M_I^2$ .

Figure 9 shows the Fourier spectra of the discharge current modulation (a) and the laser radiation power modulation (b). The horizontal axis represents the harmonic number ( $n$ ). Along the vertical axis is the logarithm of the current amplitude in arbitrary units for Fig. 9a and the logarithm of the laser radiation power, which is also in arbitrary units for Fig. 9b.

We obtained the following by analyzing the combination of Figs. 5–9:

1. The lifetime of the upper laser level relative to the spontaneous transitions in the working mixture according to (2) is  $\sim 400$  ms. The period of the smallest modulation frequency is 10 ms ( $f = 100$  Hz). Therefore, the discharge current modulation, regardless of the frequency and depth of modulation, cannot directly lead to the effects shown in Figs. 5–9. These effects are associated with the creation of an acoustoplasma state.



**Fig. 9.** Fourier components of the discharge current amplitude (a) and the laser radiation power (b) for the first 10 harmonics of the fundamental modulation frequency  $f = 100$  Hz

2. It follows from Figs. 6–9 that the discharge current modulation at a frequency  $f = 100$  Hz causes a modulation of the laser radiation power, i.e., the lifetime of the upper laser level with the induced transition is less than the modulation period (10 ms). An increase in the amplitudes of the third and fourth harmonics of the Fourier spectrum of the laser power and the absence of the fifth harmonic indicate that the lifetime of the upper laser level at the induced transition is greater than 2 ms. The frequency of the first longitudinal acoustic resonance of the cavity formed by the discharge tube is also of the order of 400–500 Hz; therefore, it follows from Fig. 9 that the contribution of the fourth harmonic to the total laser radiation power is much (almost three times) greater than the contribution of the fourth harmonics in the discharge current. For the current, the contribution for the fourth harmonic  $\{I(4)/I(1-4)\} = 0.046$ . For the discharge, the electric power is proportional to the first degree of the current, and not the second, as for the condensed media. For the laser power  $\{W_{\text{opt}}(4)/W_{\text{opt}}(1-4)\} = 0.12$ , where  $I(4)$  is the amplitude of the fourth harmonic current,  $I(1-4)$  is the sum of the amplitudes of the harmonic currents from

the first to the fourth;  $W_1(4)$  is the amplitude of the laser power at the fourth harmonic; and  $W_1(1-4)$  is the sum of the amplitudes of the laser power at the harmonics from the first to the fourth. The additional measurements made earlier (1999) showed that at a modulation frequency of the current of the order of  $f = 1$  kHz and higher, no modulation of the laser radiation was found.

3. The modulation depth of the laser radiation power nonlinearly depends on the modulation depth of the discharge current and has a threshold character. No modulation of the radiation power is observed with a current modulation depth of less than 0.3. The modulation depth of the radiation power at the current modulation depth  $M_1 = 0.6$  is  $M_W = 0.11$ . A  $M_1 = 0.8 - M_W = 0.6$  and  $M_1 = 1.2$ , the modulation depth of the radiation power again becomes  $M_W = 0.11$ .

4. The approximation of the experimental values of the laser radiation power in the region of the current modulation depth of 0.5–1.2 is parabolic. The decrease in the radiation power modulation at a small depth of the current modulation is explained by the fact that the acoustoplasma phenomena have a threshold character, and the acoustoplasma does not arise at a small depth of current modulation [20, 21]. The acoustoplasma state is destroyed (several frequencies exist at once because of the appearance of harmonics) with a current modulation depth greater than 1; therefore, the modulation depth of the radiation power again decreases. A sharp increase in the acoustoplasma state occurs with an increase in the current modulation depth from 0.6 to 0.8. The radiation power modulation also sharply increases. With a further increase in the modulation depth from 0.8 to 1.2, the destruction of the acoustoplasma begins, and the modulation depth of the radiation decreases.

5. Figs. 2 and 3 show that the acoustoplasma interaction and the power of the laser radiation strongly depend on the working mixture composition.

#### 4. Conclusion

The following conclusions are derived from the present study:

1. The optimization of the CO<sub>2</sub> laser operation in the acoustoplasma mode (i.e., the dependence of the laser power on the composition of the working mixture, pressure, direct current, frequency, and modulation depth) was considered. The gain in radiation power during the transition to the acoustoplasma mode was 1.5 times compared with the supply with a direct current. The other parameters remained unchanged.

2. These effects were associated with the creation of the acoustoplasma state because only the discharge current modulation, regardless of the frequency and modulation depth, cannot do this.

3. For the efficiency of converting electric power into optical laser power, a 3D graph was obtained depending on the frequency and modulation depth of the discharge current. The optimal modulation depth of current  $M = 0.5$ .

4. The depth of the modulated laser power depended on the modulation frequency. At frequencies  $>1$  kHz, the modulation was very small and did not depend on the modulation depth of the discharge current. At frequencies of the order of several hundred Hz, the modulation depth of the laser power was nonlinearly dependent on the modulation depth of the discharge current and had a threshold character and a parabolic form.

## References

- [1] Patel C.K.N. High Power Carbon Dioxide Lasers. *Sci. American*, 1968, vol. 219, no. 2, pp. 24–39. doi: 10.3367/UFNr.0097.196904e.0697.
- [2] Gertzberg G. *Electronic spectra and the structure of polyatomic molecules*. Moscow, Mir, 1969, 772 p. In Russian.
- [3] Ingard U. Acoustic wave generation and amplification in plasma. *Phys. Rev.*, 1966, vol. 145, no. 1, pp. 41–46. doi: 10.1103/PhysRev.145.41.
- [4] Ingard U., Schulz M. Ion density and electric field perturbations caused by an acoustic wave pulse in a weakly ionized gas. *Phys. Rev.*, 1968, vol. 11, no. 3, pp. 688–689. doi: 10.1063/1.1691978.
- [5] Fitaire M., Maritei T.D. Some experimental results on acoustic wave propagation in a plasma. *Physics of Fluids*, 1972, vol. 15, no. 3, pp. 464–469. doi: 10.1063/1.1693930
- [6] Kaw P. Acoustic Instability in Weakly Ionized Gases. *Phys. Rev.*, 1969, vol. 188, no. 1, pp. 508–511. doi: 10.1103/PhysRev.188.506.
- [7] Nedospasov A.V., Hait V.L. *Vibrations and instabilities of low-temperature plasma*. Moscow, Nauka, 1979, 168 p. In Russian.
- [8] Osipov A.I., Uvarov A.V. Stability problems in a nonequilibrium gas. *Physics-Uspekhi*, 1996, vol. 39, no. 6, pp. 597–608. doi:10.3367/UFNr.0166.199606c.0639.
- [9] Fedorenko A.S.. Ph.D., Thesis. Moscow, 1980 (In Russian).
- [10] Galechyan G.A., Mkrtychyan A.R. *Acoustoplasma*. Yerevan, Apaga, 2005, p. 338. (In Russian)
- [11] Mkrtychyan A.R., Mkrtychyan A.H., Abrahamyan A.S. Acoustoplasma is a new state of plasmas. 2012, VII Int. Conf. Plasma Phys. and Plasma Technology, Minsk, Belarus.
- [12] Laser LG-23. Instruction, p. 15.
- [13] Mkrtychyan A.R., Abrahamyan A.S., Abrahamyan K.A., Gevorgyan S.A., Kostanyan R.B. Continuous CO<sub>2</sub> laser using acoustoplasma interaction. 2002, International Conference on Laser Physics, Ashtarak, Armenia.
- [14] Milenin V.M., Timofeev N.A. *Plasma of gas-discharge light sources of low pressure*. Leningrad, Leningrad State University, 1991, 240 p.
- [15] Bessonov L.A. *Theoretical Foundations of Electrical Engineering*. Moscow, High School, 1967, 775 p.
- [16] Gilmore R. *Catastrophe theory for scientists and engineers*. Philadelphia, Pennsylvania, Drexel University, 1981, 240 p.
- [17] Abrahamyan A.S., Chilingaryan R.Yu., Sahakyan Q.G. Catastrophe Theory and Phase Transition Study in Acoustoplasma. 2012, VII Int. Conf. Plasma Phys. and Plasma Technology, Minsk, Belarus.
- [18] Haroyan K.P. Ph.D., Thesis. Yerevan, 2005.
- [19] Chilingaryan S.A. Jump and Nonlinear Phenomena in Acoustoplasma. 2010, Republican Scientific Conference of Young Scientists.
- [20] Mkrtychyan A.R., Torosyan O.S. Amplification of acoustic waves in weakly ionized plasma. *Acoust. Journ.*, 1999, vol. 45, no. 5, pp. 633–641.
- [21] Torosyan O.S., Mkrtychyan A.R. Theory of acoustic instability and behavior of the phase velocity of sound waves in a weakly ionized plasma. *Physica Plazmy*, 2003, vol. 29, no. 4, pp. 346–354.

*Received: 19.07.2018*